

# Serie 090

## CONNESSIONI AUTOMOTIVE

### Terminali + connettori

Connettori: PBT  
 Terminale: lega di rame

TERMINALE  
FEMMINA **A**

TERMINALE  
MASCHIO **B**

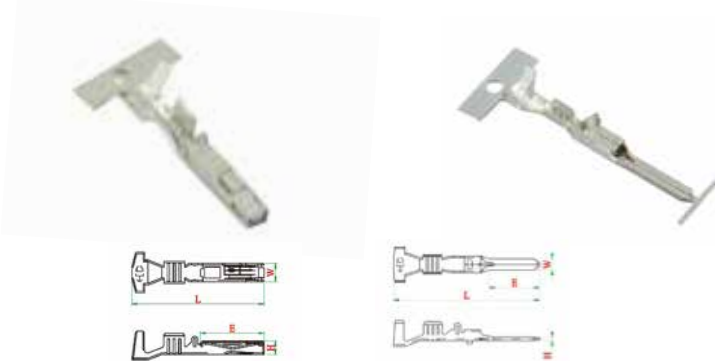

RIF	CODICE	MATERIALE	TRATTAM.	SEZ. FILO	H	W	L	E	SPESS.	CONF.	NOTE
A	E618648	KS	2	0.30 - 0.50	2.2	3	21.1	10.2	0.25	3000	
	E618647	KS	2	1.25 - 2.00	2.2	3	21	10.2	0.25	3000	
M	E618523	BS	2	0.30 - 0.50	0.6	1.9	25.9	/	0.30	4000	
	E618522	BS	2	1.25 - 2.00	0.6	1.9	25.9	/	0.30	5000	

CONNETTORE  
PORTA FEMMINA

**ENMWP02FB**  
2VIE



**A**



CONNETTORE  
PORTA MASCHIO

**EMWP02MB**  
2VIE



**B**



CONNETTORE  
PORTA FEMMINA

**ENMWP06FB**  
6VIE



**C**



RIF	CODICE	MATERIALE	COLORE	TERMINALE	L	H	W	CONF.	RETAINER
A	ENMWP02FB	PBT	Nero	E618647 E618648	30.1	21.3	24.6	100	ENMWP02FB-C
B	EMWP02MB	PA66	Nero	E618522 E618523	41.9	18	21.4	100	EMWP02MB-C
C	ENMWP06FB	PBT	Nero	E618647 E618648	29	29.9	27	100	ENMWP06FB-C

# Serie 090

## CONNESSIONI AUTOMOTIVE

### Terminali + connettori

Connettori: PA66  
 Terminale femmina: ottone

TERMINALE  
 FEMMINA **F**



RIF	CODICE	MATERIALE	TRATTAM.	SEZ. FILO	H	W	L	E	SPESS.	CONF.	NOTE
F	E810208	KS	2	0,30 - 0.50	25.9	0.6	1.9	/	0.25	5000	

CONNETTORE  
 PORTA FEMMINA

**EHX02FGY**  
 2VIE



**A**



CONNETTORE  
 PORTA FEMMINA

**EHX03FB**  
 3VIE

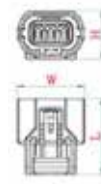

**B**



CONNETTORE  
 PORTA FEMMINA

**EHXB05FB**  
 5VIE

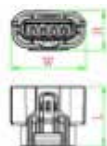

**C**



RIF	CODICE	MATERIALE	COLORE	TERMINALE	L	H	W	CONF.	RETAINER
A	EHX02FGY	PBT	Grigio	E810208	15.5	17.5	24.5	100	EHX02FGY-C
B	EHX03FB	PBT	Nero	E810208	24.4	15.4	21.6	100	EHX03FB-C
C	EHXB05FB	PA66	Nero	E810208	24.5	16.1	30.25	100	EHXB05FB-C

# Serie 090

## CONNESSIONI AUTOMOTIVE

### Connettori + Terminali + Guarnizioni di tenuta

Connettori: PBT  
Terminali: ottone

TERMINALE FEMMINA **A**

TERMINALE MASCHIO **B**

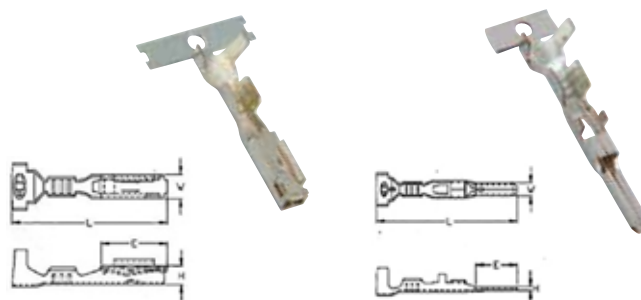

RIF	CODICE	MATERIALE	TRATTAM.	SEZ. FILO	H	W	L	E	SPESS.	CONF.	NOTE
F	E617047	KS	2	0.85 – 2.0	2.3	3.0	18.2	7.5	1.25	3000	
	E617048	KS	2	0.3 – 0.5	2.3	3.0	18.2	7.5	0.25	3000	
M	E617147	KS	2	0.85 – 1.25	0.6	2.2	23.7	7.0	0.3	3000	
	E617148	KS	2	0.3 – 0.5	0.6	2.2	23.7	7.0	0.3	3000	

GOMMINO DI TENUTA

E5901001930

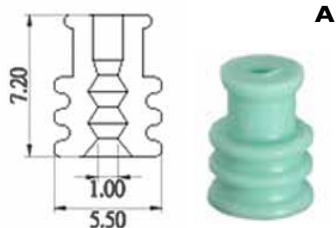

GOMMINO DI TENUTA

E5901002010

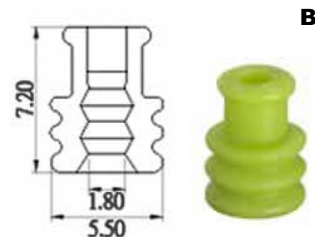

RIF	CODICE	MATERIALE	COLORE	CONFEZIONE	TERMINALE	DIAM. ISOLANTE	NOTE
A	E5901001930	SIR-503	Azzurro	1000	E617048 E617148	1.4 – 1.6	
B	E5901002010	SIR-503	Verde	1000	E617047 E617048	1.8 – 2.5	

# Serie 090

## CONNESSIONI AUTOMOTIVE

### Connettori

CONNETTORE  
PORTA FEMMINA

ERS02FGY-M  
2VIE

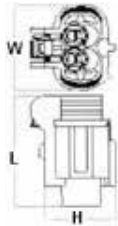

CONNETTORE  
PORTA MASCHIO

ERS02MGY-M  
2VIE

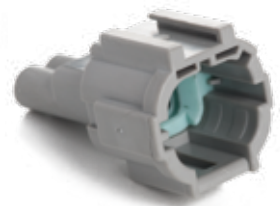
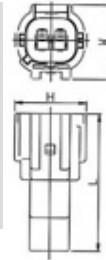

CONNETTORE  
PORTA MASCHIO

ERS04MGY-M  
4VIE

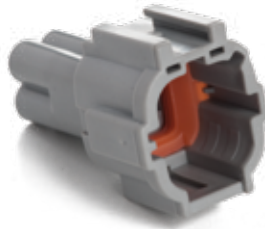
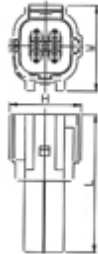

CONNETTORE  
PORTA FEMMINA

ERS06FGY-M  
6VIE

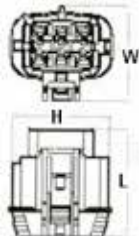

CONNETTORE  
PORTA MASCHIO

ERS06MGY-M  
6VIE

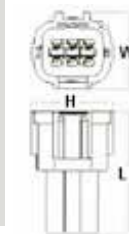

RIF	CODICE	MATERIALE	COLORE	TERMINALE	L	H	W	CONF.	RETAINER
C	ERS02FGY-M	PBT	Grigio	E617048	26.20	16.40	20.10	100	ERS02FDY-C
D	ERS02MGY-M	PBT	Grigio	E617148	41.8	22.0	22.7	100	ERS02MGY-C
E	ERS04MGY-M	PBT	Grigio	E617148	41.8	21.8	26.0	100	ERS04MGY-C
F	ERS06FGY-M	PBT	Grigio	E617048	26.30	24.60	23.25	100	ERS06FGY-C
G	ERS06MGY-M	PBT	Grigio	E617148	41.90	27.70	26.05	100	ERS06MGY-C

# Serie 090

## CONNESSIONI AUTOMOTIVE

### Connettori + Terminali

Connettori: PBT  
Terminali: ottone

TERMINALE  
FEMMINA **F**

TERMINALE  
MASCHIO **M**

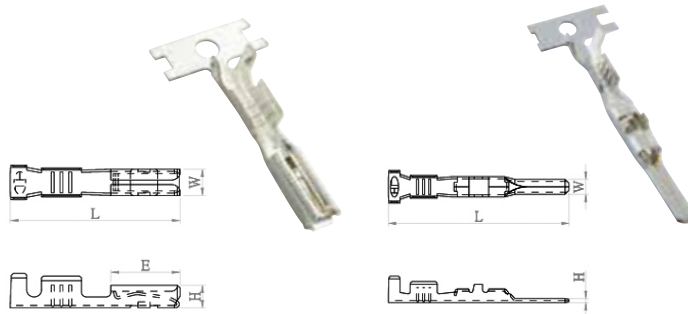

RIF	CODICE	MATERIALE	TRATTAM.	SEZ. FILO	H	W	L	E	SPESS.	CONF.	NOTE
F	E617001	BS	2	0.85 - 1.25	2.5	2.9	17.4	7.1	0.25	4000	
	E617002	BS	2	0.5 - 0.85	2.5	2.9	17.4	7.1	0.25	4000	
	E617003	BS	2	0.3 - 0.5	2.5	2.9	17.4	7.1	0.25	4000	
M	E617101	BS	2	0.85 - 1.25	0.6	2.2	26.7	8.0	0.3	4000	
	E617102	BS	2	0.5 - 0.85	0.6	2.2	26.7	8.0	0.3	4000	
	E617103	BS	2	0.3 - 0.5	0.6	2.2	26.7	8.0	0.3	4000	

CONNETTORE  
PORTA FEMMINA

ESL-1BSL  
1VIA



**A**

CONNETTORE  
PORTA MASCHIO

ESL-1ASL  
1VIA



**B**

CONNETTORE  
PORTA FEMMINA

ESL-2BSL  
2VIE



**C**

CONNETTORE  
PORTA MASCHIO

ESL-2ASL  
2VIE

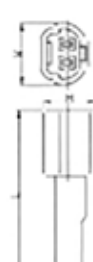

**D**

CONNETTORE  
PORTA FEMMINA

ESL-3BSL  
3VIE



**E**

CONNETTORE  
PORTA FEMMINA

ESL-4BSL  
4VIE

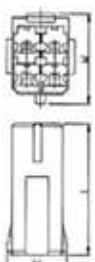

**F**

CONNETTORE  
PORTA MASCHIO

ESL-4ASL  
4VIE

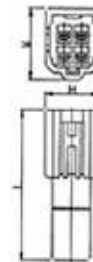

**G**

# Serie 090

## CONNESSIONI AUTOMOTIVE

### Connettori

CONNETTORE  
PORTA FEMMINA

ESL-6BSL  
6VIE

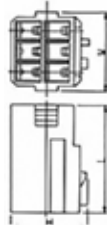

H

CONNETTORE  
PORTA MASCHIO

ESL-6ASL  
6VIE



I

RIF	CODICE	MATERIALE	COLORE	TERMINALE	L	H	W	CONF.	NOTE
A	ESL-1BSL	NL 66	Naturale	E617001 E617002 E617003	20.3	5.9	5.0	500	
B	ESL-1ASL	NL 66	Naturale	E617101 E617102 E617103	33.50	4.70	4.70	500	
C	ESL-2BSL	NL 66	Naturale	E617001 E617002 E617003	20.9	10.2	5.0	100	
D	ESL-2ASL	NL 66	Naturale	E617101 E617102 E617103	35.8	10.5	12.5	100	
E	ESL-3BSL	NL 66	Naturale	E617001 E617002 E617003	20.9	14.4	9.1	100	
F	ESL-4BSL	NL 66	Naturale	E617001 E617002 E617003	20.9	10.6	12.0	100	
G	ESL-4ASL	NL 66	Naturale	E617101 E617102 E617103	35.8	12.5	17.1	100	
H	ESL-6BSL	NL 66	Naturale	E617001 E617002 E617003	20.9	13.6	13.1	100	
I	ESL-6ASL	NL 66	Naturale	E617101 E617102 E617103	35.8	16.1	15.3	100	

CONNETTORE  
PORTA FEMMINA

EDJ7061-3.5-21  
6VIE

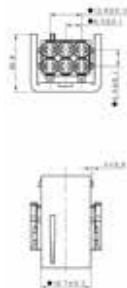

A

CONNETTORE  
PORTA MASCHIO

EDJ7026-1.2-11  
2VIE

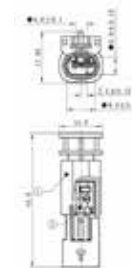

B

RIF	CODICE	MATERIALE	COLORE	TERMINALE	L	H	W	CONF.	NOTE
A	EDJ7061-3.5-21	PA66+GF	Nero	EDJ623-E3.5	15.2	36.7	26.5	100	PER TERMINALI CONTATTARE UFF.COMMERCIALE
B	EDJ7026-1.2-11	PA66+GF	Nero	EDJ611-1.2-0.6	44.0	10.8	14.8	100	PER TERMINALI CONTATTARE UFF.COMMERCIALE

# Serie 090

## CONNESSIONI AUTOMOTIVE

### Connettori

Connettori: PBT  
Terminali: ottone

TERMINALE  
FEMMINA **F**

TERMINALE  
MASCHIO **M**

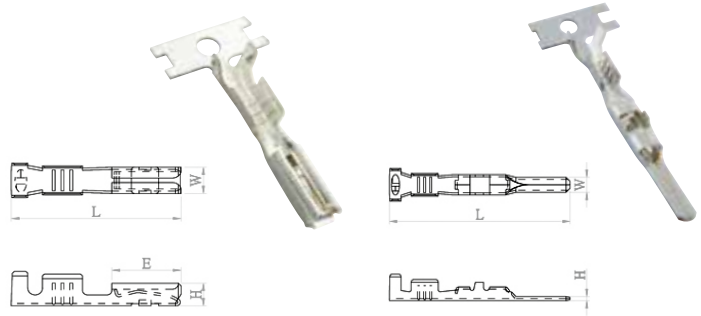

RIF	CODICE	MATERIALE	TRATTAM.	SEZ. FILO	H	W	L	E	SPESS.	CONF.	NOTE
F	E617001	BS	2	0.85 - 1.25	2.5	2.9	17.4	7.1	0.25	4000	
	E617002	BS	2	0.5 - 0.85	2.5	2.9	17.4	7.1	0.25	4000	
	E617003	BS	2	0.3 - 0.5	2.5	2.9	17.4	7.1	0.25	4000	
M	E617101	BS	2	0.85 - 1.25	0.6	2.2	26.7	8.0	0.3	4000	
	E617102	BS	2	0.5 - 0.85	0.6	2.2	26.7	8.0	0.3	4000	
	E617103	BS	2	0.3 - 0.5	0.6	2.2	26.7	8.0	0.3	4000	

CONNETTORE  
PORTA FEMMINA

ENTL-6BSL  
6VIE

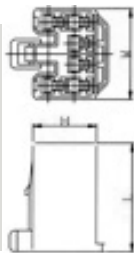

**A**

CONNETTORE  
PORTA MASCHIO

ENTL-6ASL  
6VIE



**B**

CONNETTORE  
PORTA FEMMINA

ENTL-8BSL  
8VIE

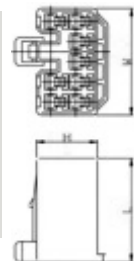

**C**

CONNETTORE  
PORTA MASCHIO

ENTL-8ASL  
8VIE

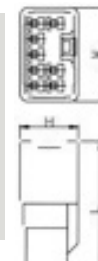

**D**

CONNETTORE  
PORTA FEMMINA

ENTL-10BSL  
10VIE

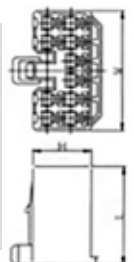

**E**

CONNETTORE  
PORTA MASCHIO

ENTL-10ASL  
10VIE

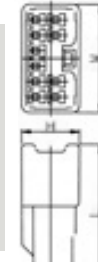

**F**

CONNETTORE  
PORTA FEMMINA

ENTL-12BSL  
12VIE

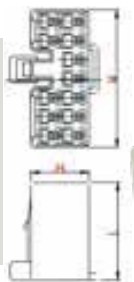

**G**

CONNETTORE  
PORTA MASCHIO

ENTL-12ASL  
12VIE

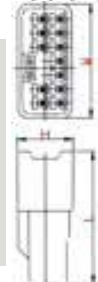

**H**

# Serie 090

## CONNESSIONI AUTOMOTIVE

### Connettori

CONNETTORE  
PORTA FEMMINA

ENTL-14BSL  
14VIE

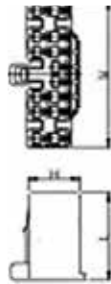

CONNETTORE  
PORTA MASCHIO

ENTL-14ASL  
14VIE

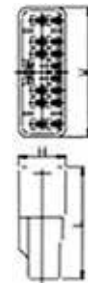

CONNETTORE  
PORTA FEMMINA

ENTL-18FG  
18VIE



CONNETTORE  
PORTA FEMMINA

ENTL-22BSL  
22VIE



RIF	CODICE	MATERIALE	COLORE	TERMINALE	L	H	W	CONF.	NOTE
A	ENTL-6BSL	NL 66	Naturale	E617001 E617002 E617003	20.8	12.1	17.3	100	
B	ENTL-6ASL	NL 66	Naturale	E617101 E617102 E617103	36.0	15.6	20.2	100	
C	ENTL-8BSL	NL 66	Naturale	E617001 E617002 E617003	20.8	12.1	21.2	100	
D	ENTL-8ASL	NL 66	Naturale	E617101 E617102 E617103	36.0	15.6	24.3	100	
E	ENTL-10BSL	NL 66	Naturale	E617001 E617002 E617003	20.8	12.1	25.2	100	
F	ENTL-10ASL	NL 66	Naturale	E617101 E617102 E617103	36.0	15.6	28.3	100	
G	ENTL-12BSL	NL 66	Naturale	E617001 E617002 E617003	20.8	12.1	29.2	100	
H	ENTL-12ASL	NL 66	Naturale	E617101 E617102 E617103	36.0	15.6	32.8	100	
I	ENTL-14BSL	NL 66	Naturale	E617001 E617002 E617003	20.8	12.1	39.2	100	
L	ENTL-14ASL	NL 66	Naturale	E617101 E617102 E617103	36.0	15.6	42.6	100	
M	ENTL-18FG	NL 66	Verde	E617001 E617002 E617003	20.8	12.1	55.2	100	
N	ENTL-22BSL	NL 66	Verde	E617001 E617002 E617003	20.8	12.1	55.2	100	